

INSTRUCTION MANUAL

Solar Meter

MS-01
MS-02

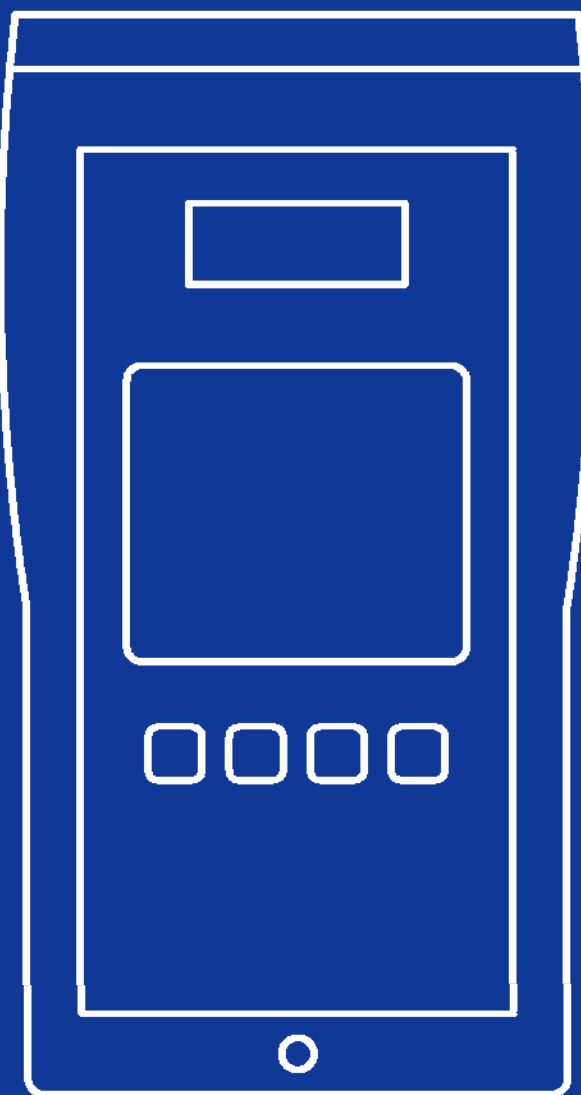

EKO

1. Index

1. Index	1
2. Important User Information	2
2-1. Contact Information	2
2-2. Warranty and Liability	2
2-3. About Instruction Manual	3
2-4. Environment	3
3. Safety Information	4
3-1. WARNING/CAUTION	4
4. Introduction	5
4-1. Main Functions	5
4-2. Package Contents	5
5. Operation	6
5-1. Parts Name	6
5-2. Setup	6
5-3. Measuring	7
5-4. Downloading to PC (MS-02 Only)	9
5-5. Data Logging (MS-02 only)	9
6. Maintenance	11
6-1. Maintenance	11
6-2. Calibration/Recalibration	11
7. Specification	12
7-1. Main Unit	12
7-2. Software	13
7-3. Dimensions	13

2. Important User Information

Thank you for using EKO Products

Make sure to read this instruction manual thoroughly and to understand the contents before starting to operate the instrument. Keep this manual at safe and handy place for whenever it is needed.

For any questions, please contact us at one of the EKO offices given below:

2-1. Contact Information

EKO INSTRUMENTS CO., LTD.

Asia, Oceania Region

www.eko-asia.com	EKO INSTRUMENTS Co., Ltd.	Tel: +81 (3) 3469-6713
info@eko.co.jp	1-21-8 Hatagaya, Shibuya-ku Tokyo, 151-0072 Japan	Fax: +81 (3) 3469-6719

Europe, Middle East, Africa, South America Region

www.eko-eu.com	EKO INSTRUMENTS Europe B.V.	Tel: +31 (0)70 3050117
info@eko-eu.com	Lulofsstraat 55, Unit 32, 2521 AL, Den Haag, The Netherlands	Fax: +31 (0)70 3840607

North America Region

www.eko-usa.com	EKO INSTRUMENTS USA Inc.	Tel: +1 408-977-7751
info@eko-usa.com	95 South Market Street, Suite 300 San Jose, CA 95113 USA	Fax: +1 408-977-7741

2-2. Warranty and Liability

For warranty terms and conditions, contact EKO or your distributor for further details.

EKO guarantees that the product delivered to customer has been verified, checked and tested to ensure that the product meets the appropriate specifications. The product warranty is valid only if the product has been installed and used according to the directives provided in this instruction manual.

In case of any manufacturing defect, the product will be repaired or replaced under warranty. However, the warranty does not apply if:

- Any modification or repair was done by any person or organization other than EKO service personnel.
- The damage or defect is caused by not respecting the instructions of use as given on the product brochure or the instruction manual.

2-3. About Instruction Manual

Copy Rights Reserved by EKO INSTRUMENTS CO., LTD. Making copies of whole or parts of this document without permission from EKO is prohibited.

This manual was issued: 2018/05/31
Version Number: V1

2-4. Environment

1. WEEE Directive 2002/96/EC (Waste Electrical and Electronic Equipment)

This product is not subjected to WEEE Directive 2002/96/EC however it should not be mixed with general household waste. For proper treatment, recovery and recycling, please take this product(s) to designated collection points.

Disposing of this product correctly will help save valuable resources and prevent any potential negative effects on human health and the environment, which could otherwise arise from inappropriate waste handling.

2. RoHS Directive 2002/95/EC

EKO Instruments has completed a comprehensive evaluation of its product range to ensure compliance with RoHS Directive 2002/95/EC regarding maximum concentration values for substances. As a result all products are manufactured using raw materials that do not contain any of the restricted substances referred to in the RoHS Directive 2002/95/EC at concentration levels in excess of those permitted under the RoHS Directive 2002/95/EC, or up to levels allowed in excess of these concentrations by the Annex to the RoHS Directive 2002/95/EC.

3. Safety Information

EKO Products are designed and manufactured with consideration for safety; however, please make sure to read and understand this instruction manual thoroughly to be able to operate the instrument safely in the correct manner.



WARNING CAUTION

Attention to user; pay attention to the instructions given on the instruction manual with this sign.



3-1. WARNING/CAUTION

- This equipment should only be used by suitably trained personnel.
- This equipment is intended for use in a dry environment only.
- Check this equipment and all associated cables and leads before operating the equipment.
- Do not use if there are signs of damage.
- Only use the connecting leads and temperature probes supplied with this equipment.
- Use 2x 1.5V AA Cells – there maybe Alkaline or rechargeable NiCd or NiMH.

4. Introduction

Solar Meter MS-01 and MS-02 are suitable for environmental measurements during the inspection of the PV system construction site with its ability to measure the solar irradiance, ambient temperature, panel tilt angle, bearing angle, and PV panel back surface temperature.

Solar Meter MS-02 can record environmental conditions, and the recorded data can download to PC by connecting with USB. This convenient feature leads to time saving of construction site inspection process and improving traceability.

4-1. Main Functions

- Sturdy and light weight body is suitable for carrying around and allows to take measurements easily.
- PV panel direction and tilt angle can be measured.
- Both temperature for PV panel back surface and ambient temperature can be measured.
- MS-02 has data logging function and can be connected to PC via USB.

4-2. Package Contents

Check the package contents first; if any missing item or damage is noticed, please contact EKO immediately.

Table 4-1 Package Contents

Standard Items	Qty.	Remarks
Solar Meter MS-01/MS-02	1	
Temperature Probes	1	
USB Cable	1	Only for MS-02
Utility CD	1	Software only for MS-02
Quick Start Guide	1	
Warranty	1	

5. Operation

5-1. Parts Name

Each part name and its main functions are described below.

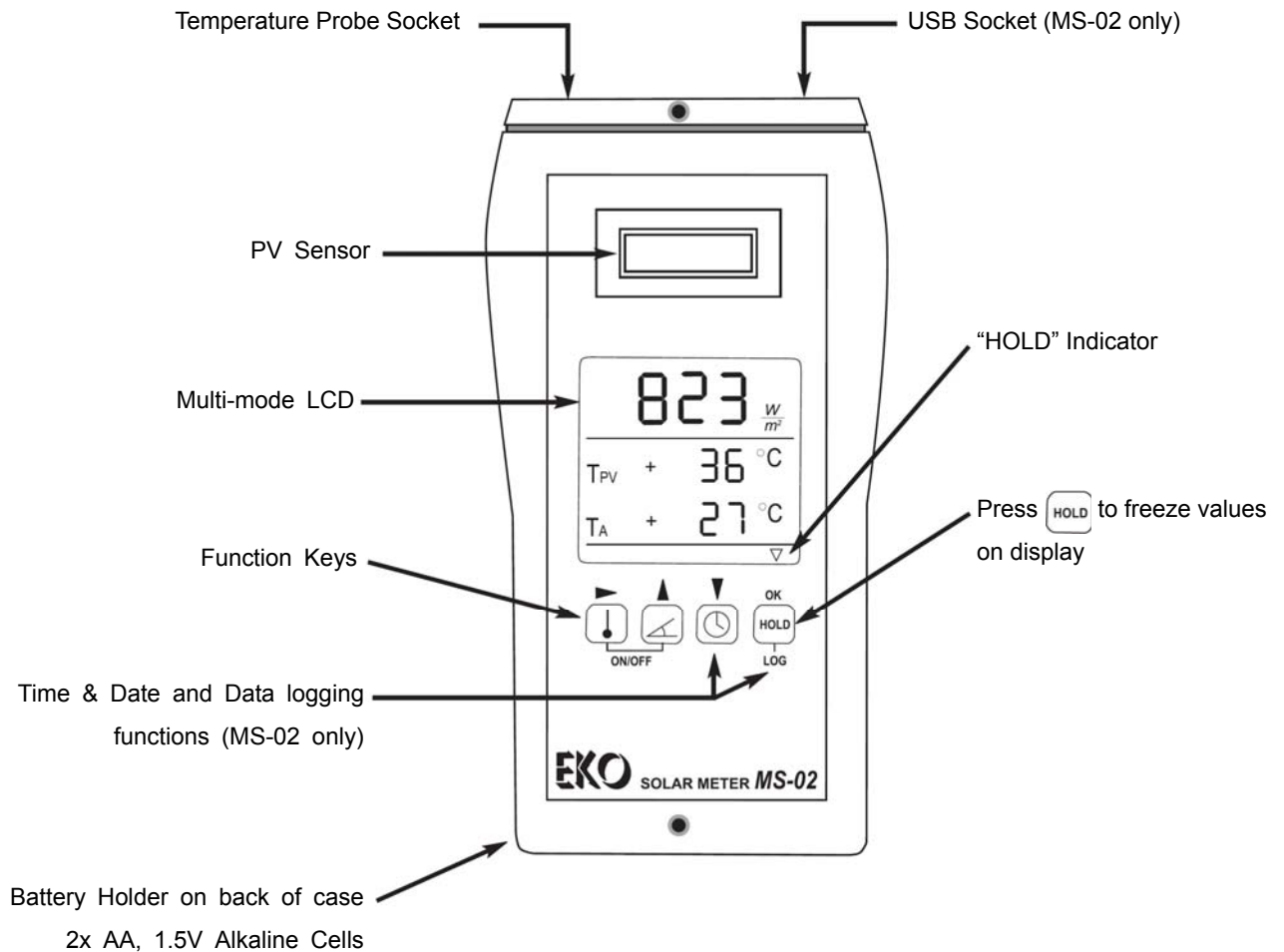

5-2. Setup





1. Power

Press  to turn power on/off.

MS-01/MS-02 always powers up in ANGLE Mode.

Power will turn off automatically if no key is pressed for 120s.

2. Time & Date (MS-02 only)



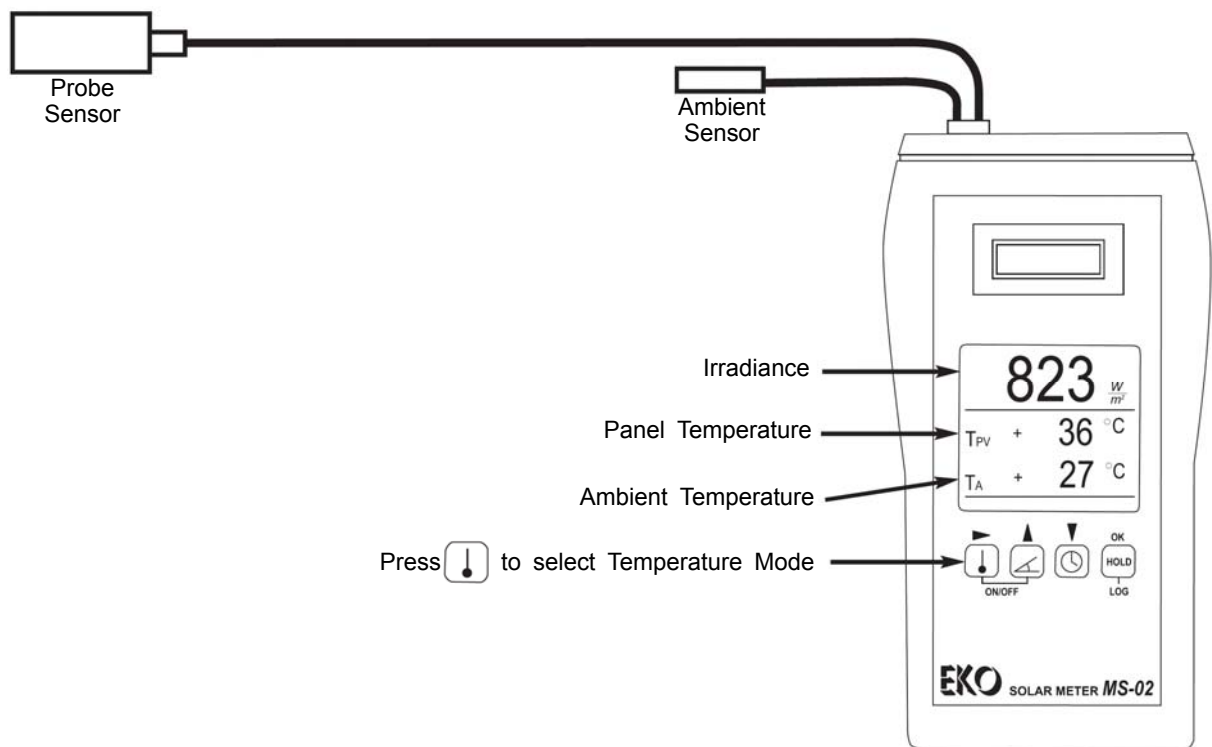

- 1) Press  >5s – display will flash hours value.
- 2) Use  to select date/time fields (flashing).
- 3) Use  &  to increase/decrease value
- 4) Press OK to save.

5-3. Measuring

1. Irradiance and Temperature Measurement



To change display units

- 1) Press  >5s.
- 2) Use  to select temperature or irradiance units (flashing).
- 3) Use  or  to toggle units (C or F), (W/m^2).
- 4) Press OK to save.

NOTE: Minimum irradiance is $100W/m^2$

2. Irradiance with Compass & Tilt Measurement

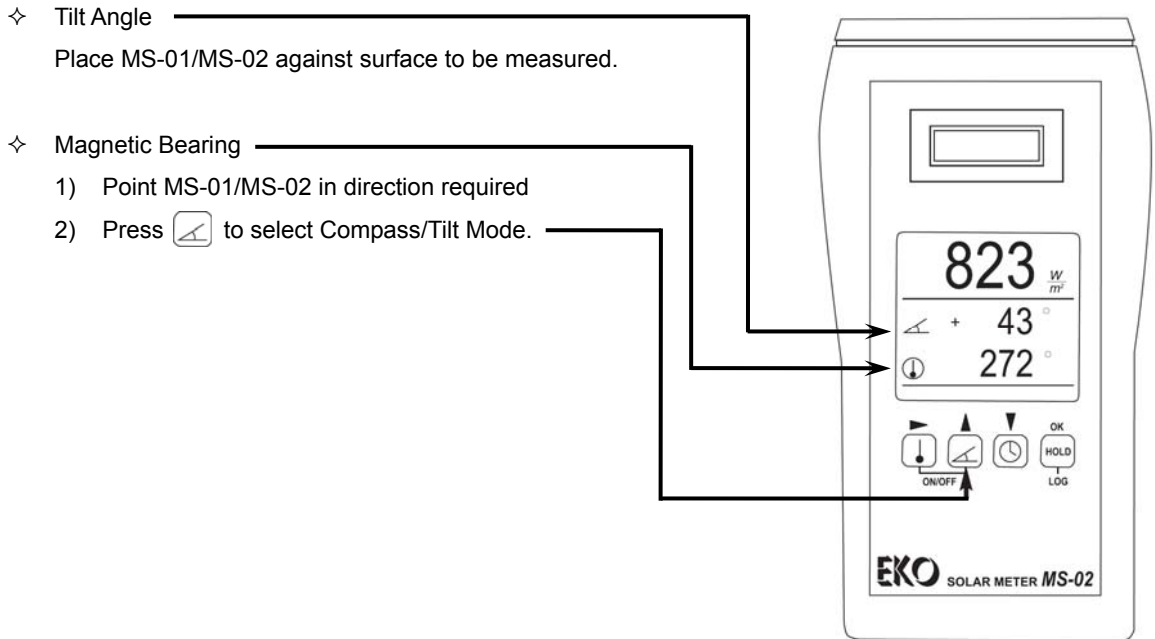

- ✧ Compass
- Keep MS-01/MS-02 away from magnetic objects – these can influence reading.
 - Keep MS-01/MS-02 horizontal – Tilting more than $\pm 20^\circ$ will bank the bearing display (-).





- ✧ User Adjustment of TILT Function
- 1) Place MS-01/MS-02 on a flat surface.
 - 2) Press  >5s – display will flash “Z”.
 - 3) Press  to store “+SET” value.
 - 4) Turn MS-01/MS-02 through 180° .
 - 5) Press  to store “-SET” value.
 - 6) MS-01/MS-02 will display “Z” to show user zero is enabled.
 - 7) To clear this, press  for >5s -- “Z” will clear.

Table 5-1 Accuracy

	Accuracy
Irradiance	\pm (5% of reading + 5W)
Temperature	$\pm 1^\circ\text{C}$
Magnetic Bearing	$\pm 8^\circ$ (flat and horizontal)
Tilt Angle	$\pm 2^\circ$

5-4. Downloading to PC (MS-02 Only)

- 1) Connect the MS-02 to PC using the USB cable.
- 2) Run the Data Downloading software on the PC.
- 3) Select the correct COM port. Use the "Help" menu – "Troubleshooting" to find the correct COM port.
- 4) Click the Download button.
- 5) Specify a folder and file name to save the data then save it.

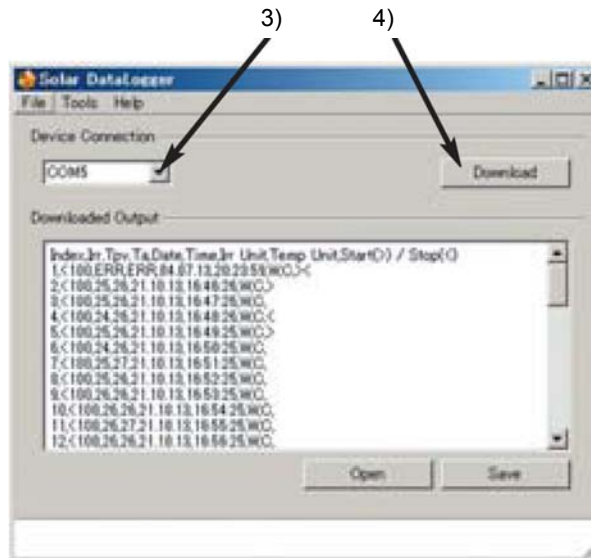

Support OS: Windows 7/8/8.1

5-5. Data Logging (MS-02 only)

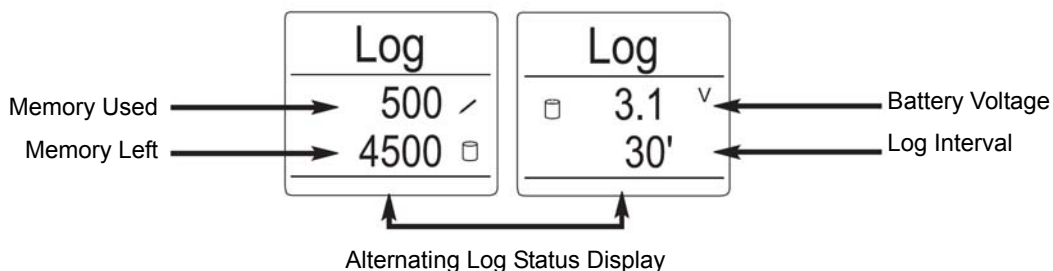

1. Log Setup

- 1) Press **HOLD** >5s to display Log Status.
- 2) Press **HOLD** >5s to display Log Interval in minutes.
- 3) Use **▲** & **▼** to increase/decrease value
- 4) Press **▶** to display Data Store Mode.
- 5) Use **▲** & **▼** to select STOP (when memory is full) or ROLL for data to overwrite memory from start.
- 6) Press **▶** to display Delete option
- 7) Use **▲** & **▼** to select YES or NO.
- 8) Press OK at any time to save & exit Log Setup.

2. Starting Data Logging

- 1) Press **HOLD** >5s to display Log Status.
- 2) Press LOG then OK to confirm RUN.

MS-01/MS-02 will enter SLEEP mode between measurements to conserve battery power.

3. Check Logging Progress

- 1) Press any key to display Log Status.
- 2) Display automatically blanks after a few seconds.

4. Stop Data Logging

- 1) Press any key to display Log Status.
- 2) Press LOG then OK to confirm STOP.

6. Maintenance

6-1. Maintenance

To maintain accurate measurement, it is recommended to check and do the following:

1. Cleaning the MS-01/MS-02

Clean the external case of the MS-01/MS-02 with a clean dry cloth.

Avoid using solvents and abrasive scouring agents to clean the external case of the MS-01/MS-02.

Check the battery contacts and compartments are free of electrolytic contamination.

Any contamination of the battery contacts or compartment should be cleaned with a dry cloth.

2. Battery Replacement

- 1) Power the unit off.
- 2) Disconnect all the test probes and leads from the unit
- 3) Push the bottom of MS-01/MS-02 with your hand to remove the blue rubber cover.
- 4) Position the MS-01/MS-02 face down.
- 5) Remove the battery compartment cover (marked with red box in below image).
- 6) Remove the discharged batteries from the compartment.
- 7) Fit a new set of alkaline batteries.
- 8) Relocate the battery cover over the battery compartment and put the blue cover back on the MS-01/MS-02 unit.



Step 3



Step 4 & 5



Step 6 & 7

6-2. Calibration/Recalibration

It is recommended to recalibrate the instrument periodically. For further information about the calibration and recalibration, please contact EKO.

7. Specification

7-1. Main Unit

Table 7-1. Main Unit Specification

Characteristics		MS-01	MS-02
Solar Irradiance	Display Range	100 to 1500W/m ²	
	Measurement Range	100 to 1250 W/m ²	
	Resolution	1W/m ²	
Temperature	Display Range	-30 to 125°C	
	Measurement Range	-30 to 125°C	
	Resolution	1°C	
Bearing Angle	Display Range	0 to 360°	
	Measurement Range	0 to 360°	
	Resolution	1°	
Tilt Angle	Display Range	0 to 90°	
	Measurement Range	0 to 90°	
	Resolution	1°	
Data Logging	---	Maximum of 5000 data Sampling interval 1 to 60min.	
Communication	---	Connection to PC via USB.	
Display	LCD		
Power Supply	2x 1.5V AA Cells Alkaline or rechargeable NiCd or NiMH maybe used		
Battery Life	More than 20,000 measurements		
Automatic Power OFF	After 2 minutes		
Size	150mm x 80mm x 33.5mm		
Weight	212g	270g	

7-2. Software

Table 7-2 Software Specifications

Items	Details
Applicable OS	Microsoft Windows 7/8/8.1
Software Function	Data downloading

7-3. Dimensions

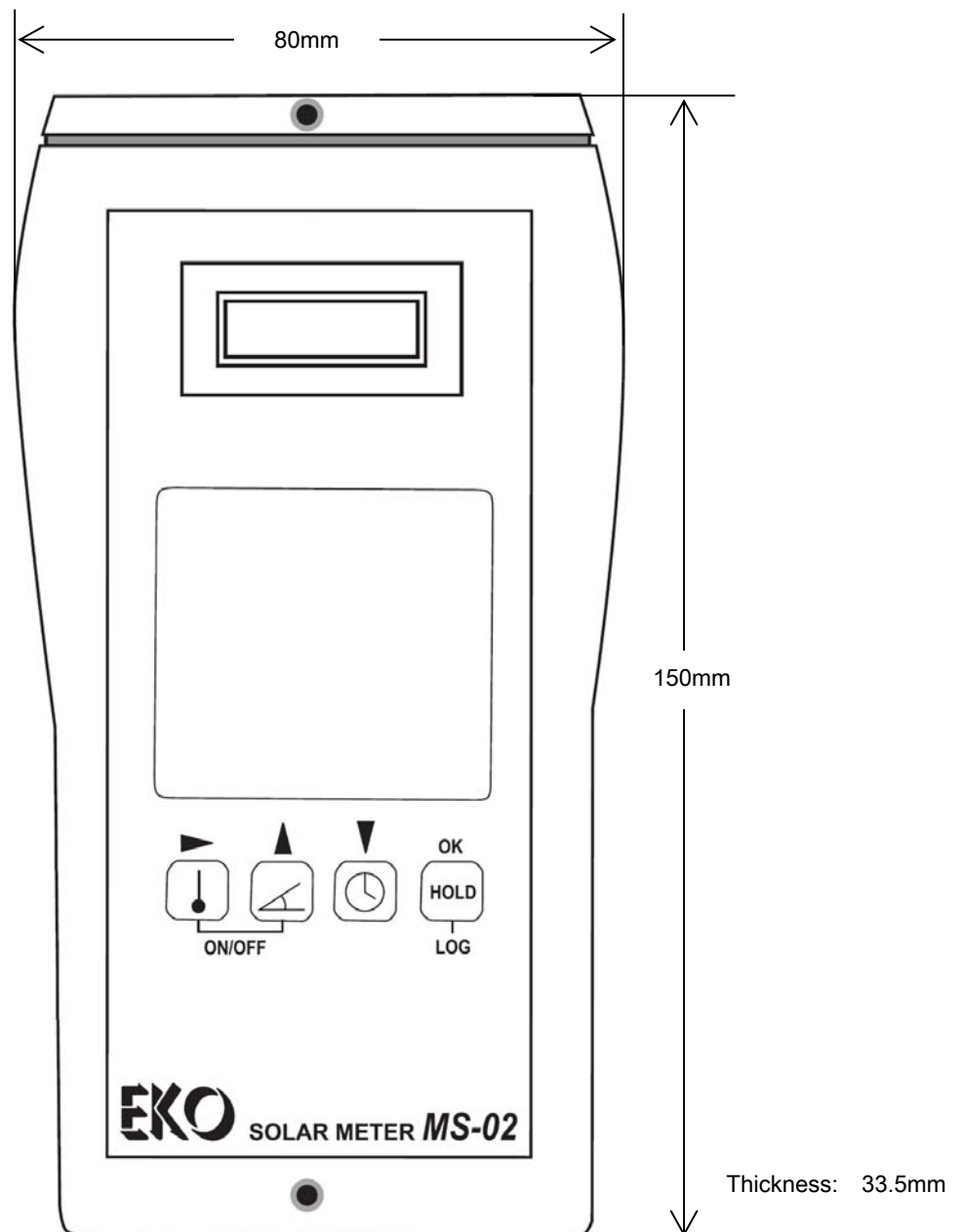



EKO Asia, Oceania

1-21-8 Hatagaya,
Shibuya-ku, Tokyo
151-0072 Japan
P. +81.3.3469.6711
F. +81.3.3469.6719
info@eko-asia.com
www.eko.co.jp

EKO North America

95 South Market Street,
Suite 300, San Jose,
CA 95113, USA
P. +1-408-977-7751
F. +1-408-977-7741
info@eko-usa.com
www.eko-usa.com

**EKO Europe,
Middle East, Africa,
South America**

Lulofsstraat 55, Unit 32,
2521 AL, Den Haag,
The Netherlands
P. +31 (0)70 3050117
F. +31 (0)70 3840607
info@eko-eu.com
www.eko-eu.com